

GROUND FLOOR PLAN

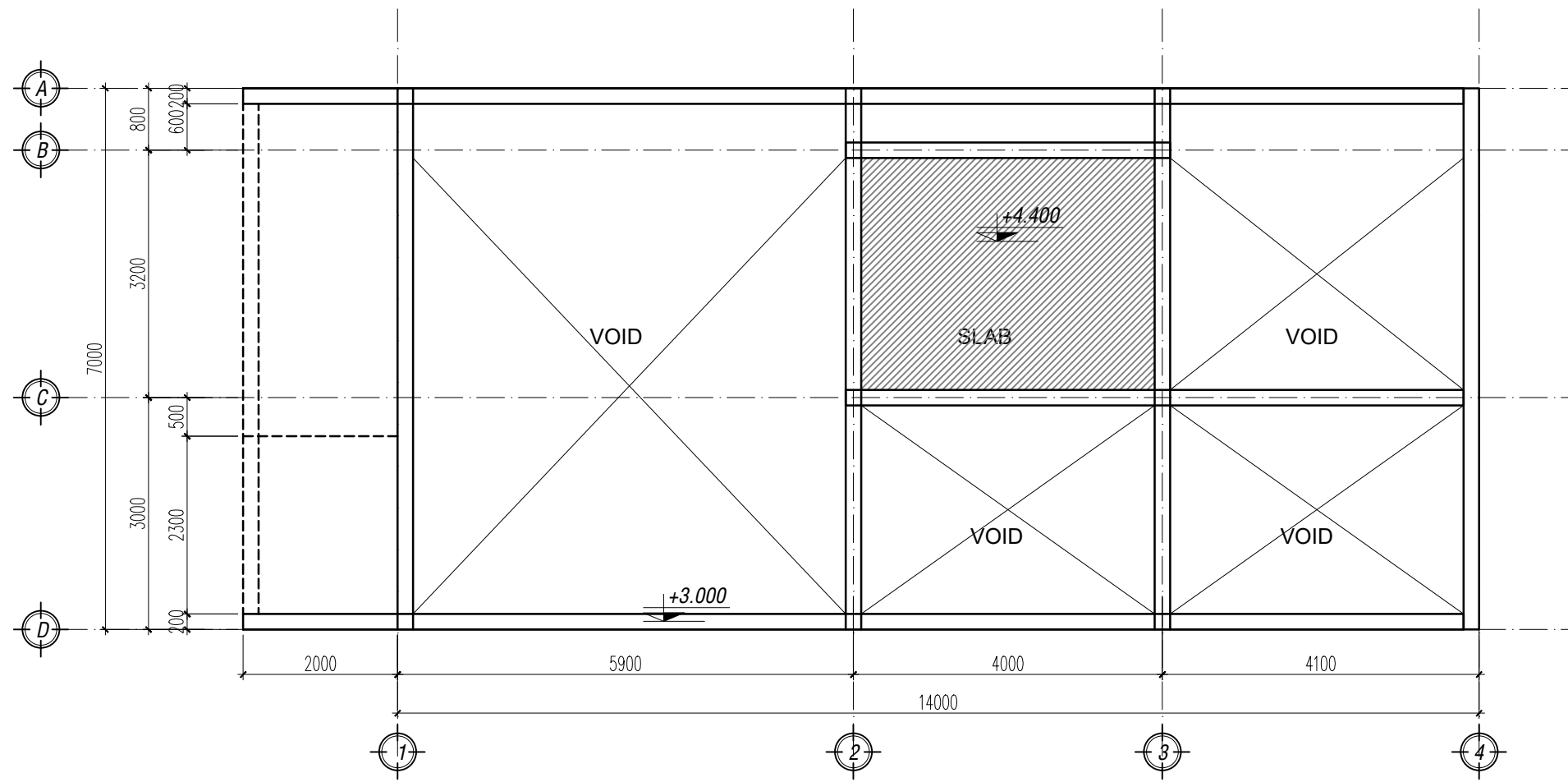

FLOOR PLAN AT +3.400

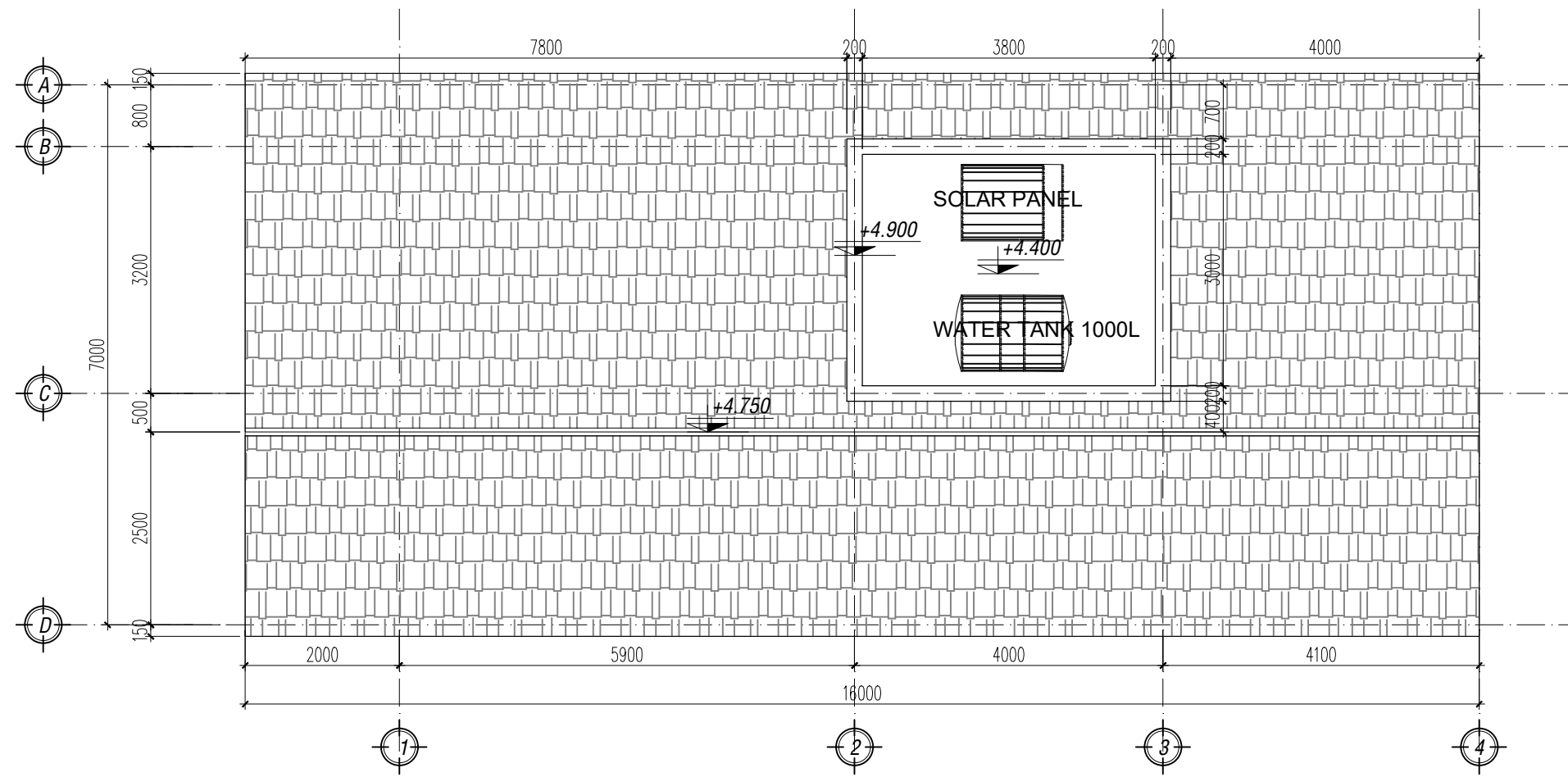



ROOF FLOOR PLAN

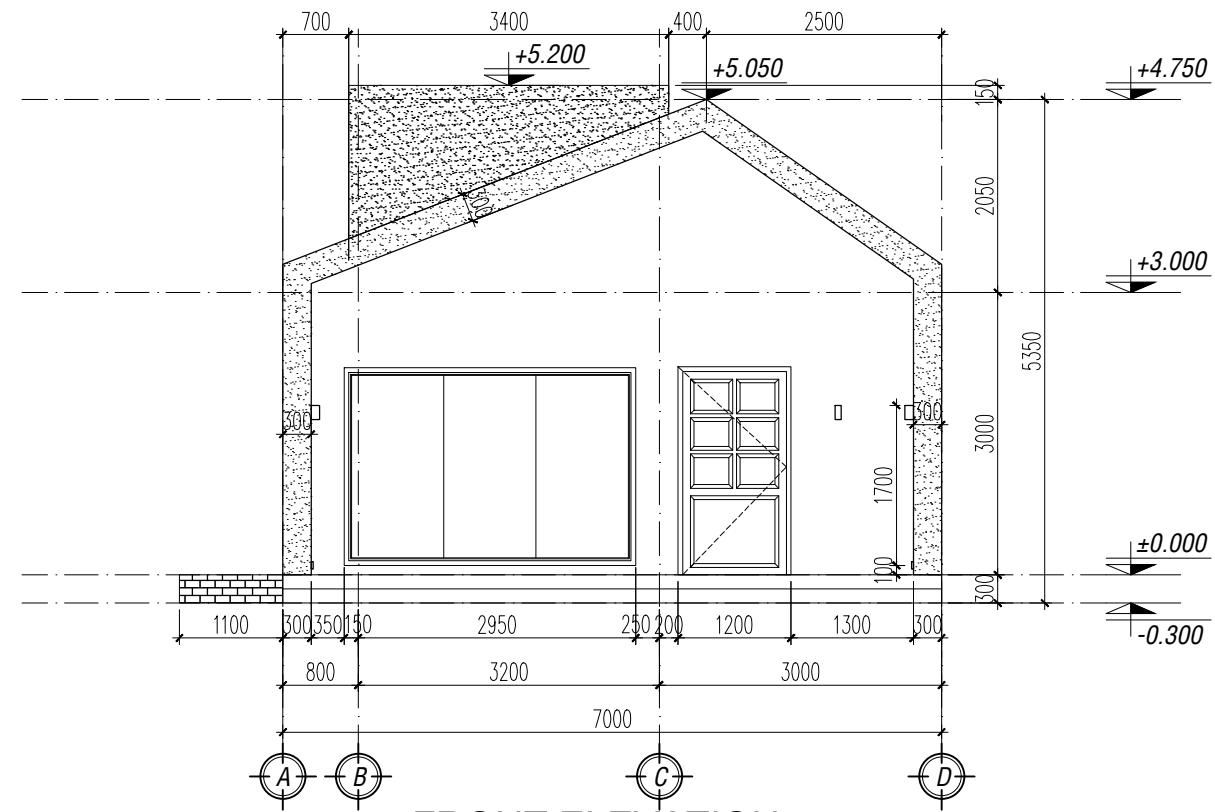

FRONT ELEVATION

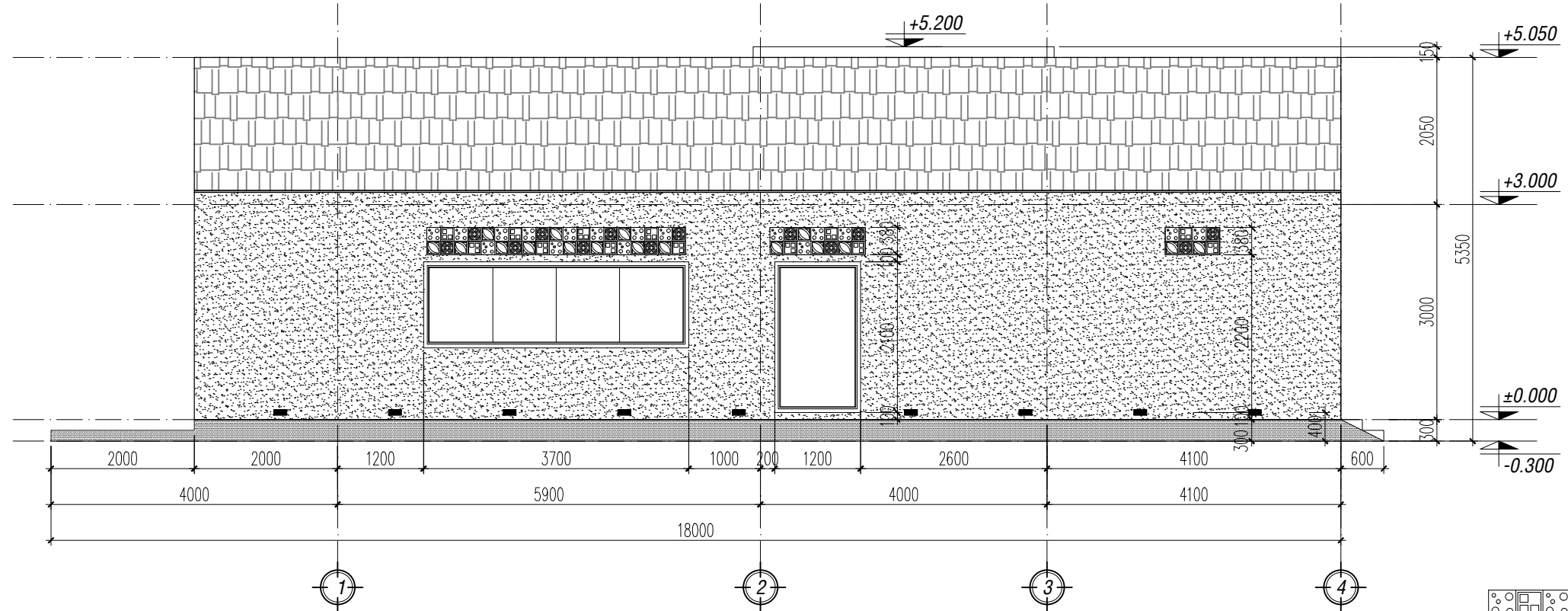

RIGHT ELEVATION

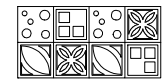

BRICK BLOCKS



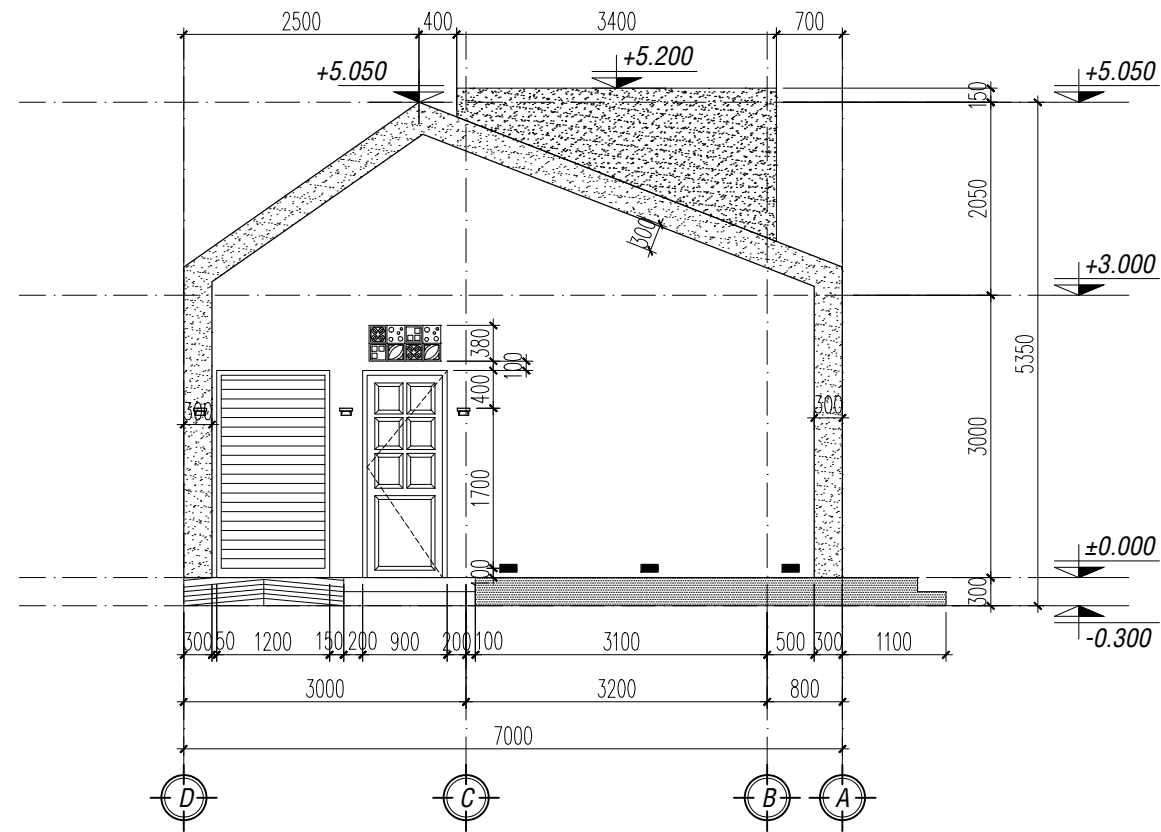

REAR ELEVATION

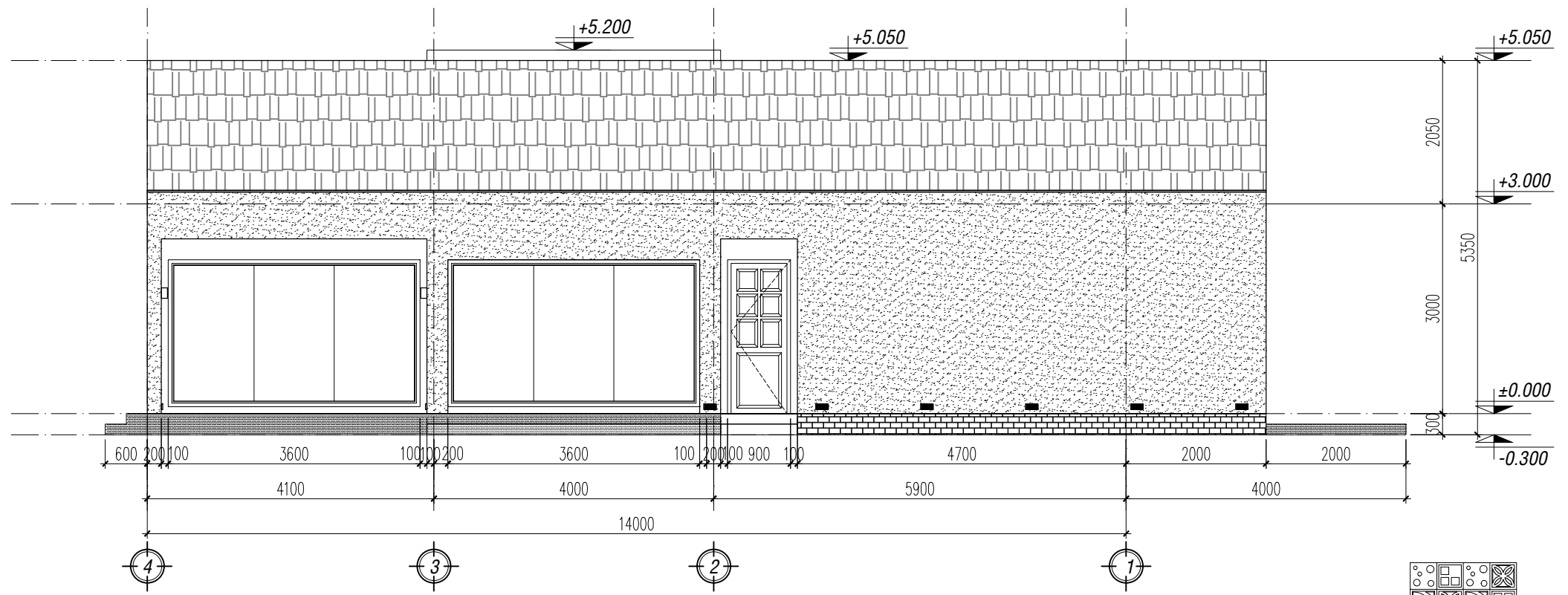

LEFT ELEVATION

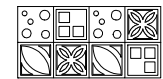

BRICK BLOCKS

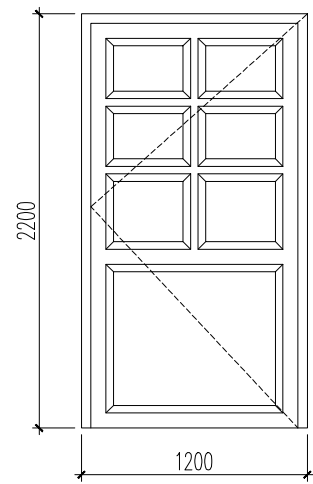

D1

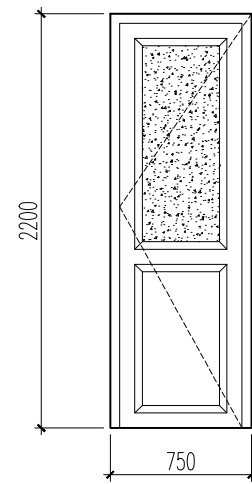

D2

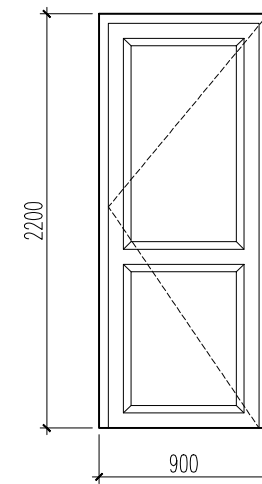

D3

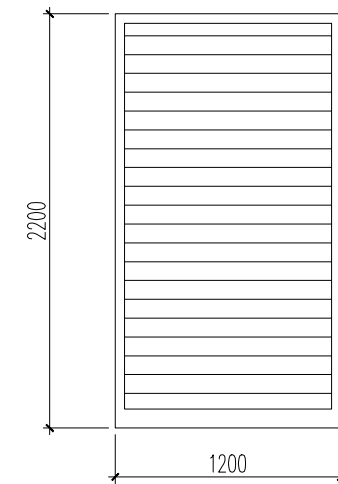

RD

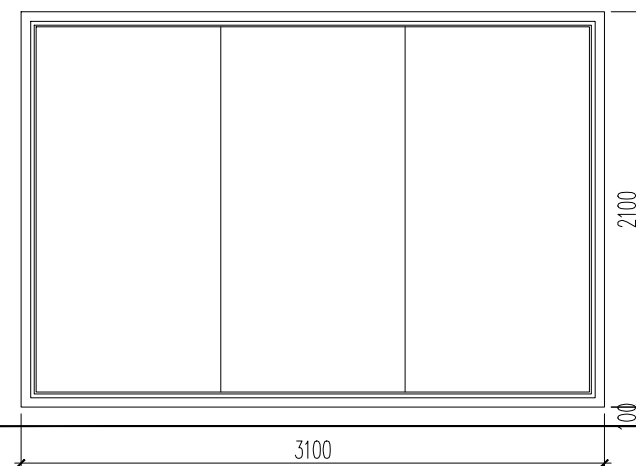

K1

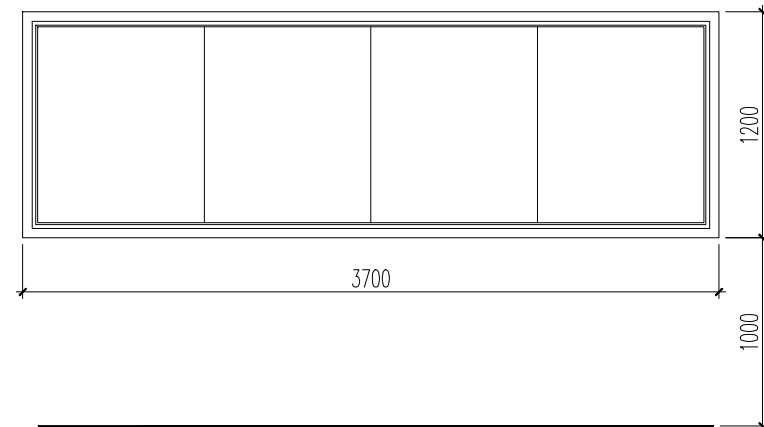

K2

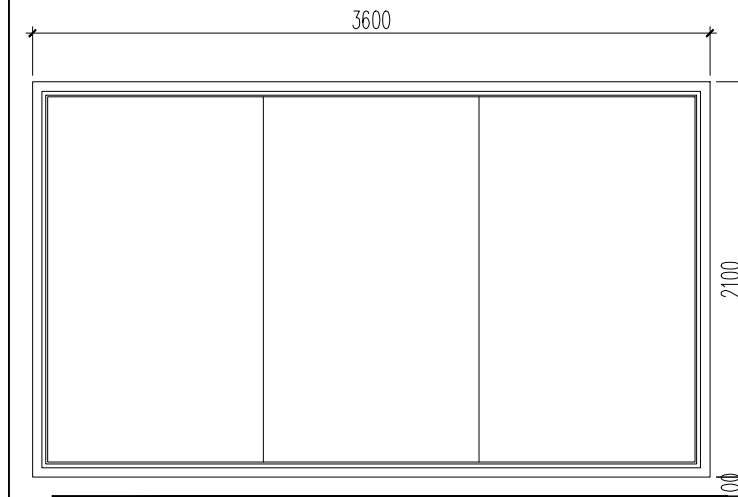

K4

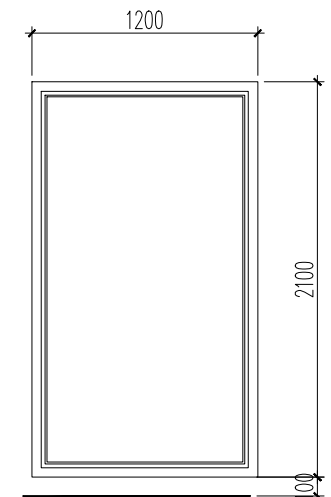

K3

